

## PRODUCT SPECIFICATION

|                 |   |
|-----------------|---|
| <b>Customer</b> |   |
| <b>Project</b>  |   |
| <b>Part No.</b> | Z43026-P40-总成 1   |
| <b>Remarks</b>  | <input type="checkbox"/> APPOVAL FOR SPECIFICATION ONLY<br><input checked="" type="checkbox"/> APPOVAL FOR SPECIFICATION AND SAMPLE |

| <b>CUSTOMER</b> |         |          | <b>ZHUNYIKEJI</b> |               |                |
|-----------------|---------|----------|-------------------|---------------|----------------|
| Approved        | Checked | Prepared | Approved          | Checked       | Prepared       |
| By              | By      | By       | By                | By            | By             |
|                 |         |          |                   | Wen<br>XiaoLi | Yang<br>ZiFeng |

**Revision Record**

| <b>Rev. No.</b> | <b>Date</b> | <b>Description</b>                 |
|-----------------|-------------|------------------------------------|
| V1.0            | 2022-08-04  | Preliminary Specification Release. |
|                 |             |                                    |
|                 |             |                                    |
|                 |             |                                    |
|                 |             |                                    |
|                 |             |                                    |

**Contents**

|  |    |
|--|----|
| 1. General Specifications.....           | 3  |
| 2. Interface Definition Description..... | 4  |
| 3. Mechanical Drawing.....               | 5  |
| 4. Electrical Specifications.....        | 7  |
| 5. Delivery Inspection.....              | 11 |
| 6. Reliability Test.....                 | 13 |
| 7. Precautions.....                      | 14 |
| 8. Packing and Storage.....              | 16 |

## 1. General Specifications

| No. | Item                                    | Specification                                | Unit   |
|-----|---|--|--------|
| 1   | Display Size (Diagonal)                 | 4.3  | inch   |
| 2   | Display Resolution                      | 480(H) × RGB × 272 (V)                       | pixels |
| 3   | Pixel Pitch                             | 198(H) × 198 (V)                             | um     |
| 4   | LCM Outline Dimension<br>(Without FPC)  | 105.46 (W) × 67.16 (H) × 2.75 (T)            | mm     |
| 5   | LCD Outline Dimension                   | 100.16 (W) × 61.86 (H) × 0.8 (T)             | mm     |
| 6   | TLCM Outline Dimension<br>(Without FPC) | 126.04 (W) × 84.86 (H) × 6.75 (T)            | mm     |
| 7   | LCD Active Area                         | 95.04 (W) × 53.86 (H)                        | mm     |
| 8   | View Direction (Gray Inversion)         | FULL VIEW                                    | -      |
| 9   | Driver IC                               | SC7283-G4                                    | -      |
| 10  | Pixel Arrangement                       | RGB-Stripe                                   | -      |
| 11  | Display Mode                            | Normal Black                                 | -      |
| 12  | Pixel driving Element                   | a-Si TFT                                     | -      |
| 13  | LCD Transmittance                       | Typ.: 6.9% Min:6.2%                          | -      |
| 14  | LCD Contrast Ratio                      | Typ.: 800 Min:640                            | -      |
| 15  | FPC Version                             | Z43026-P40 V1                                | -      |
| 16  | Interface                               | RGB  | -      |
| 17  | Operating Temperature                   | -20°C~ 70°C                                  | -      |
| 18  | Storage Temperature                     | -30°C~ 80°C                                  | -      |
| 19  | Backlight Arrangement                   | LED/5 Series 2 Parallel (10 lights in total) | -      |
| 20  | Luminance                               | TBD  | nit    |
| 21  | Weight                                  | TBD  | kg     |

## 2. Interface Definition Description

### 2.1 LCM PIN

| PIN NO. | PIN DEF. | FUNCTION DESC.                         |
|---------|----------|--|
| 1       | GND      | Ground                                 |
| 2       | DISP     | Display on/off                         |
| 3       | VCI      | POWER SUPPLY( 3.3V)                    |
| 4       | IOVCC    | I/O POWER SUPPLY( 1.8V)                |
| 5-7     | GND      | Ground                                 |
| 8-15    | D0-D7    | BLUE DATA                              |
| 16-25   | NC       | No Connection                          |
| 26      | DEN      | Data enable signal in RGB I/F DE mode. |
| 27      | CLK      | Pixel clock signal in RGB I/F          |
| 28      | HSYNC    | Horizontal sync. Signal in RGB I/F.    |
| 29      | VSYNC    | Vertical sync. Signal in RGB I/F.      |
| 30-34   | NC       | No Connection                          |
| 35-36   | LEDA     | POWER SUPPLY- FOR BACKLIGHT ANODE      |
| 37-38   | LEDK     | POWER SUPPLY- FOR BACKLIGHT CATHODE    |
| 39-40   | GND      | Ground                                 |

RESET voltage should be consistent with IOVCC voltage, or there probably is black screen fault when power on.

### 2.2 TP PIN

| PIN NO. | PIN DEF. | FUNCTION DESC.                      |
|---------|----------|-------------------------------------|
| 1       | TP_VDD   | TP POWER SUPPLY                     |
| 2       | TP_SDA   | TP I2C data (SDA) data input (MOSI) |
| 3       | TP_SCL   | TP I2C clock (SCL) clock (SCLK)     |
| 4       | TP_INT   | TP Interrupt PIN                    |
| 5       | TP_RST   | TP Reset PIN                        |
| 6       | GND      | Ground                              |

## 3. Mechanical Drawing

### 3.1 LCM

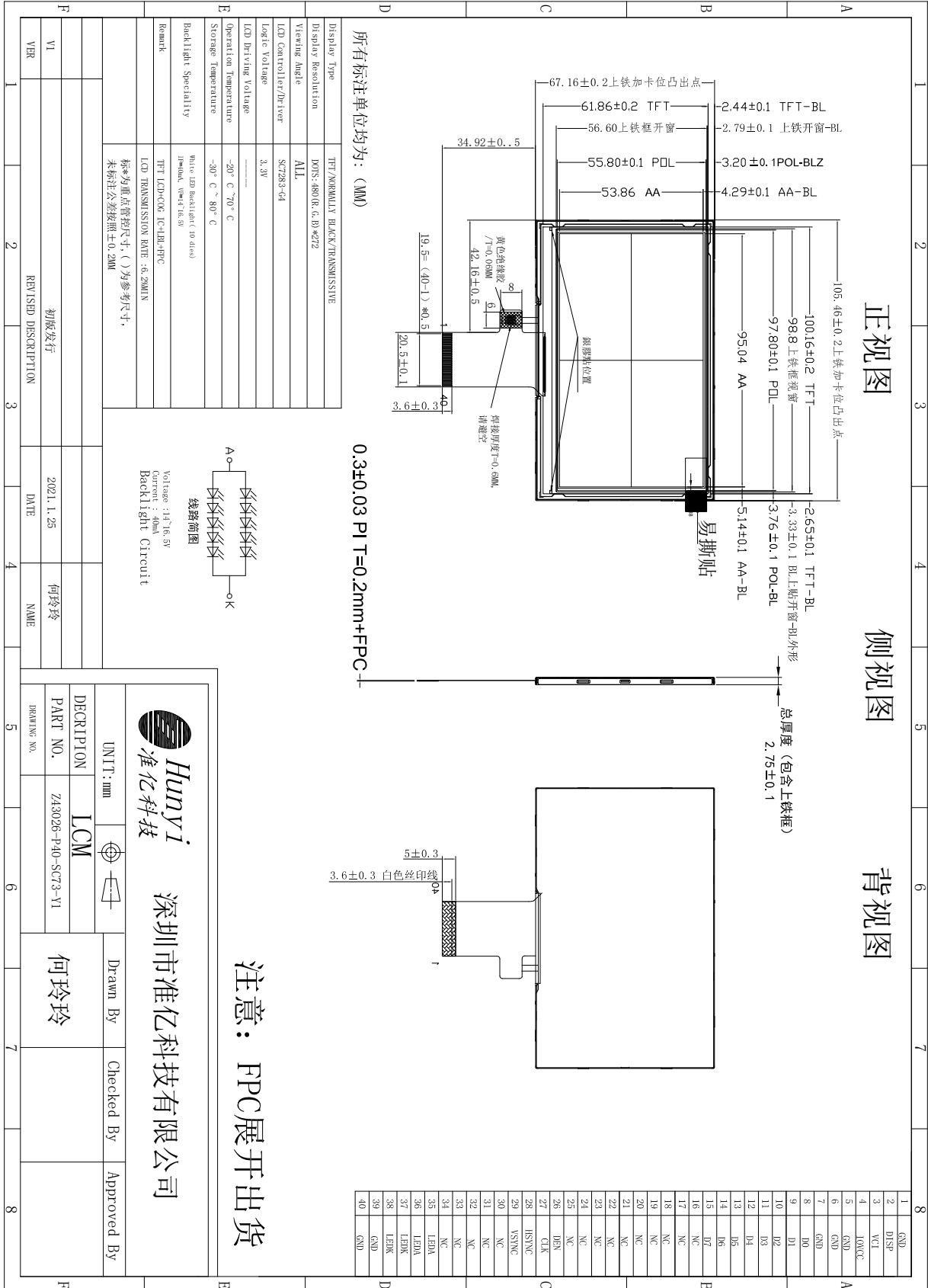



## 4. Electrical Specifications

### 4.1. LCD Optical Characteristics

| Item                    | Symbol | Conditions                             | Specification           |      |      | Unit | Note |   |
|-------------------------|--------|--|-------------------------|------|------|------|------|---|
|                         |        |  | Min.                    | Typ. | Max. |      |      |   |
| Transmittance (With PL) | T(%)   | Viewing<br>normal angle<br>$x = y = 0$ | 6.2                     | 6.9  | -    | %    | -    |   |
| Contrast Ratio          | CR     |  | 640                     | 800  | -    | -    | -    |   |
| Response Time           | TR+TF  |  | -                       | 30   | 40   | ms   | -    |   |
| Viewing Angle           | Hor.   | $\Theta_{x+}$                          | CR $\geq$ 10<br>at 25°C | 70   | 80   | -    | deg. | - |
|                         |        | $\Theta_{x-}$                          |                         | 70   | 80   | -    |      |   |
|                         | Ver.   | $\Theta_{y+}$                          |                         | 70   | 80   | -    |      |   |
|                         |        | $\Theta_{y-}$                          |                         | 70   | 80   | -    |      |   |

### 4.2. Electrical Specifications

| Item                         | Symbol | Specification |      |      | Unit |
|------------------------------|--------|---------------|------|------|------|
|                              |        | Min.          | Typ. | Max. |      |
| Power For Analog Circuit     | AVDD   | 6.2           | -    | 6.4  | V    |
| TFT Gate On Voltage          | VGH    | 13            | 14   | 16.5 | V    |
| TFT Gate Off Voltage         | VGL    | -12           | -12  | -7   | V    |
| TFT Common Electrode Voltage | Vcom   | -             | 0    | -    | V    |

### 4.3. Typical Operating Conditions

| Item                  | Symbol | Min.                      | Typ. | Max.                      | Unit |
|-----------------------|--------|---------------------------|------|---------------------------|------|
| Analog Supply Voltage | VCI    | 3.0                       | 3.3  | 3.6                       | V    |
| I/O Supply Voltage    | IOVCC  | 1.65                      | 3.3  | 3.6                       | V    |
| Input High Voltage    | VIH    | $0.7 \times \text{IOVCC}$ | -    | IOVCC                     | V    |
| Input Low Voltage     | VIL    | GND                       | -    | $0.3 \times \text{IOVCC}$ | V    |

|                     |     |             |   |           |   |
|---------------------|-----|-------------|---|-----------|---|
| Output High Voltage | VOH | IOVCC - 0.4 | - | IOVCC     | V |
| Output Low Voltage  | VOL | GND         | - | GND + 0.4 | V |

#### 4.4. Backlight Circuit Specifications

| Item                        | Symbol         | Min.           | Typ. | Max. | Unit | Test Condition   |
|-----------------------------|----------------|----------------|------|------|------|--|
| Current                     | I <sub>B</sub> | -              | 40   | -    | mA   | -  |
| Voltage                     | V <sub>f</sub> | 14             | 15   | 16.5 | V    | -  |
| LCM Uniformity              | -              | 80             | -    | -    | %    | If=40mA  |
| Life Time                   | -              | 30000          | -    | -    | Hr.  |  |
| Power Consumption           | PBL            | -              | 600  | -    | mW   |  |
| LCM Chromaticity Coordinate | Red            | R <sub>x</sub> | TBD  | TBD  | TBD  | Average the brightness<br>EV at 9 points, Optical<br>Instrument BM-7 |
|                             |                | R <sub>y</sub> | TBD  | TBD  | TBD  |  |
|                             | Green          | G <sub>x</sub> | TBD  | TBD  | TBD  |  |
|                             |                | G <sub>y</sub> | TBD  | TBD  | TBD  |  |
|                             | Blue           | B <sub>x</sub> | TBD  | TBD  | TBD  |  |
|                             |                | B <sub>y</sub> | TBD  | TBD  | TBD  |  |
|                             | White          | W <sub>x</sub> | TBD  | TBD  | TBD  |  |
|                             |                | W <sub>y</sub> | TBD  | TBD  | TBD  |  |

#### 4.5. LCD Power Consumption

| Mode   | Symbol    | Typ. | Max. | Unit |
|--|-----------|------|------|------|
| Normal Mode  | VCI+IOVCC | -    | -    | mA   |
| Test Condition: VCI=3.3V.                              |           |      |      |      |
| Interface Drive Type: row flipping or column flipping. |           |      |      |      |
| IPS Type LCD Panel => All Black Pattern.               |           |      |      |      |
| TN Type LCD Panel => All White Pattern.                |           |      |      |      |
| Temperature: 25°C.                                     |           |      |      |      |
| Mode   | Symbol    | Typ. | Max. | Unit |

|  |           |   |   |    |
|--|-----------|---|---|----|
| Sleep Mode   | VCI+IOVCC | - | - | μA |
| Test Condition: VCI=3.3V.  |           |   |   |    |
| DC/DC converter is enabled. Internal oscillator is started and panel scanning is started.        |           |   |   |    |
| Except for the IC internal crystal oscillator and panel scanning, other functions are suspended. |           |   |   |    |
| Temperature: 25°C.   |           |   |   |    |

## 4.6. Measuring System

### 4.6.1. LCM Viewing Angle

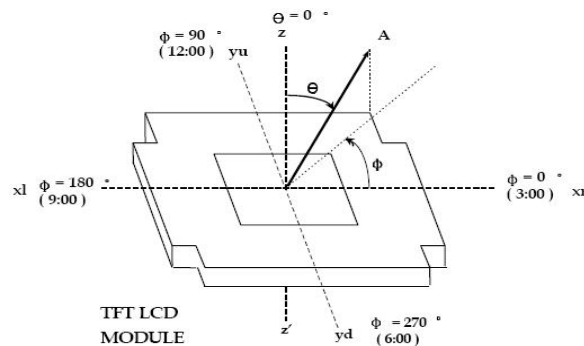

Viewing angle is the angle at which the contrast ratio is greater than 10. The angles are determined for the horizontal or x axis and the vertical or y axis with respect to the z axis which is normal to the LCD surface.

### 4.6.2. Response Time

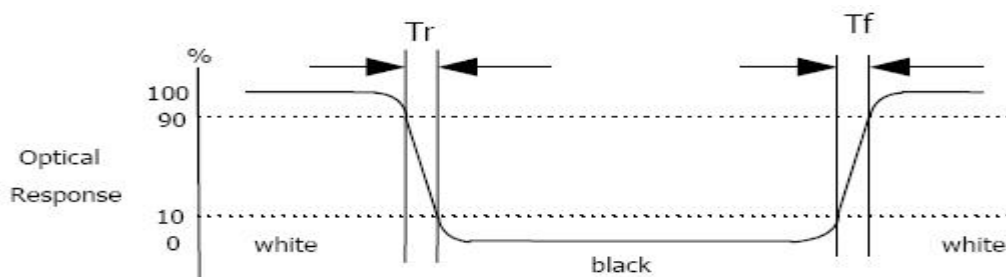

Response time is the time required for the display to transition from white to black (Rising time,  $T_r$ ) and from black to white (Falling time,  $T_f$ ) for additional information.

### 4.6.3. Contrast Ratio (CR)

Contrast Ratio (CR) is defined mathematically as:

$$\text{Contrast Ratio} = \frac{\text{Surface Luminance with all white pixels}}{\text{Surface Luminance with all black pixels}}$$

Surface luminance is the center point across the LCD surface 500mm from the surface with all pixels displaying white.

## 4.7. Power On / Power Off

### 4.7.1. Power On

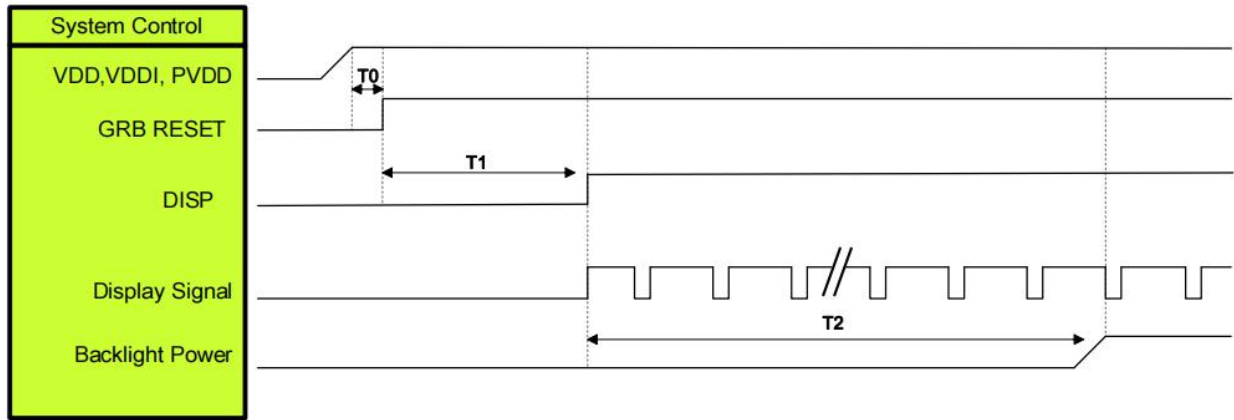

| Symbol | Description                                 | Min. Time | Unit |
|--------|---|-----------|------|
| T0     | System power stability to GRB RESET signal  | 0         | ms   |
| T1     | GRB RESET="High" to DISP="High"             | 10        | ms   |
| T2     | Display Signal output to Backlight Power on | 250       | ms   |

### 4.7.2. Power Off

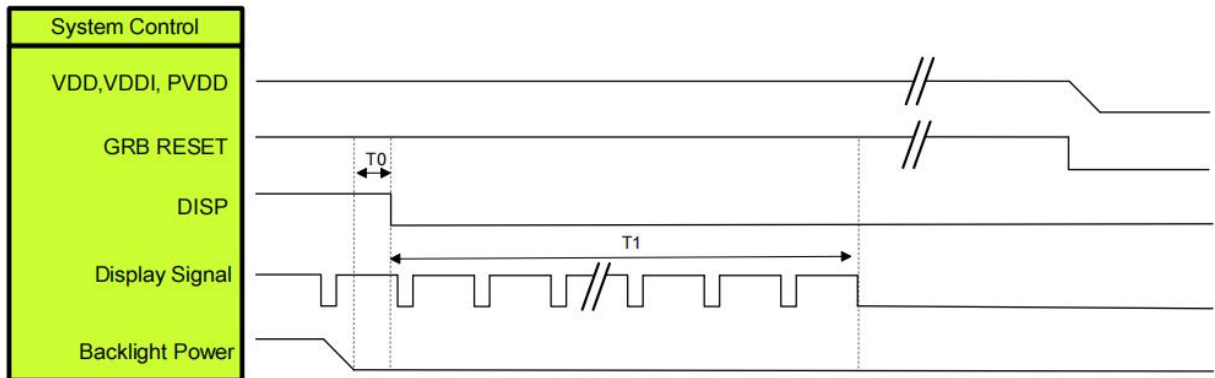

| Symbol | Description  | Min. Time | Unit |
|--------|--|-----------|------|
| T0     | Backlight Power off to DISP="Low"                    | 5         | ms   |
| T1     | DISP="Low" to IC internal voltage discharge complete | 80        | ms   |

## 5. Delivery Inspection

### 5.1. Quality Inspection Environmental Conditions

- 5.1.1. Viewing distance: the normal viewing distance between the screen and the inspector is  $30\pm 5\text{cm}$ ; Inspection Angle:  $90^\circ\pm 45^\circ$  ( $90^\circ$  indicates that the inspector's perspective is perpendicular to the product to be inspected).
- 5.1.2. Visual inspection illumination:  $1000\pm 200\text{LUX}$ ; Electrical inspection illumination:  $200\pm 100\text{LUX}$ ; Ambient temperature  $25\pm 5^\circ\text{C}$ , ambient humidity  $55\pm 15\%\text{RH}$ .

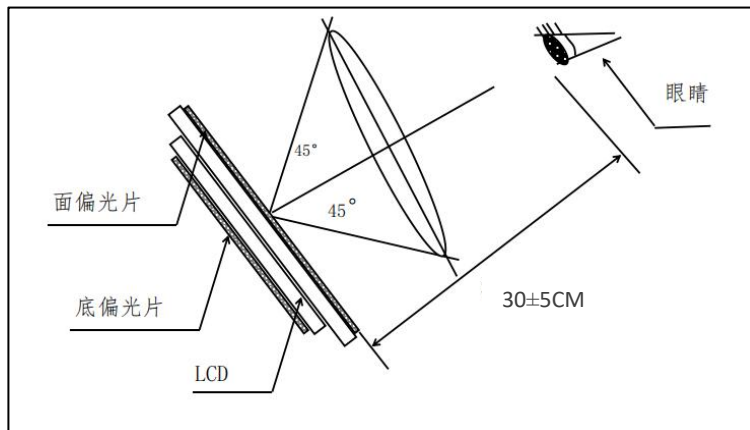

### 5.2. Quality Inspection Standard

| No.                                    | Defect   | Standard         |   | Defect Grade   | Result |
|--|--|------------------|---|----------------|--------|
| 1                                      | Spot Defect<br>(including bright spot / color spot / bubble / dark spot, etc.) | < 7 inches       | $\Phi \leq 0.10\text{mm}$                 | Ignore         | OK     |
|  |  |                  | $0.10\text{mm} < \Phi \leq 0.20\text{mm}$ | Minor Defect   | OK     |
|  |  |                  | $\text{DS} \geq 10\text{mm}$              |                |        |
|  |  | $\cong 7$ inches | $\Phi > 0.20\text{mm}$                    | Serious Defect | NG     |
|  |  |                  | $\Phi \leq 0.15\text{mm}$                 | Ignore         | OK     |
|  |  |                  | $0.15\text{mm} < \Phi \leq 0.25\text{mm}$ | Minor Defect   | OK     |
| $\text{DS} \geq 10\text{mm}$           |  |                  |   |                |        |
| $\Phi$ : defect diameter. DS: spacing. |  |                  |   |                |        |
| 2                                      | Linear Defect<br>(scratches,   | < 7 inches       | $W \leq 0.02\text{mm}$ ,<br>L: unlimited  | Ignore         | OK     |

|   |                       |   |   |                         |   |                 |
|---|-----------------------|---|---|-------------------------|---|-----------------|
|   | filaments, etc.)      |   | 0.02mm < W ≤ 0.03mm   |                         | Minor Defect  | OK              |
|   |                       |   | L ≤ 5mm   |                         |   |                 |
|   |                       | ≧ 7 inches                                  | W > 0.03mm  |                         | Serious Defect  | NG              |
|   |                       |   | W ≤ 0.03mm  |                         | Ignore  | OK              |
|   |                       |   | L: unlimited  |                         |   |                 |
|   |                       | 0.03mm < W ≤ 0.05mm                         |   | Minor Defect            | OK  |                 |
| L ≤ 5mm   |                       |   |   |                         |   |                 |
| W > 0.05mm                                      |                       | Serious Defect                              | NG  |                         |   |                 |
| W: defect width. L: defect length. DS: spacing. |                       |   |   |                         |   |                 |
| 3   | Polarizer Bubble      | Display Area                                | Judge by Spot Defect  |                         |   |                 |
|   |                       | Black Edge Area                             | The distance from the edge of the display area is greater than 0.5mm. |                         | Minor defect  | OK              |
|   |                       |   | The distance from the edge of the display area is less than 0.5mm.    |                         | Judge by Spot Defect  |                 |
| 4   | Polarizer Bump (Mark) | Display Area / Black Edge Area              | Invisible when the touch screen or cover plate is assembled.          |                         | Minor Defect  | OK              |
| 5   | Color and Luminance   | Item  | Method  | Instrument              | Median  | Tolerance Range |
|   |                       | Color                                       | x, y Color Coordinate   | Optical Instrument BM-7 | According to the actual test on the sample confirmed by the customer. | ± 0.04          |
|   |                       | Luminance                                   | Average the brightness EV at 9 points                                 | Optical Instrument BM-7 | According to the actual test on the sample confirmed by the customer. | ± 20%           |
| 6   | Other Standards       | Subject to the negotiation by both parties. |   |                         |   |                 |

|   |                 |  |
|---|-----------------|--|
| 7 | Warranty Period | One year after sale.   |
| 8 | Guarantee       | ROHS、REACH   |
| 9 | Websites        | Official: <a href="https://en.zhunyiikeji.com/">https://en.zhunyiikeji.com/</a><br>Goble Resources: <a href="https://zhunyi.manufacturer.globalsources.com/">https://zhunyi.manufacturer.globalsources.com/</a><br>Alibaba: <a href="https://zhunyiikeji.en.alibaba.com/">https://zhunyiikeji.en.alibaba.com/</a><br>1688: <a href="https://shop9641057ru80o3.1688.com/">https://shop9641057ru80o3.1688.com/</a> |

## 6. Reliability Test

| Item                               | Condition  | Result Determination   |
|------------------------------------|--|--|
| High-Temperature Storage           | 85°C 120H  | After the test, leave the LCD samples indoors at normal temperature and humidity for 2H for function and appearance inspection.<br>The sample should meet the requirements on electrical performance, but be free from the following defects:<br>1. Air bubble in the module,<br>2. No display,<br>3. Glass crack. |
| Low-Temperature Storage            | -30°C 120H   |  |
| High-Temperature Operation         | 85°C 120H  |  |
| Low-Temperature Operation          | -30°C 120H   |  |
| High-Temperature and High-Humidity | 60°C 90%RH 120H  |  |
| Thermal Cycling Test               | -30°C/0.5H ~ +85°C/0.5H<br>100 cycles in total   |  |
| Vibration Test                     | Frequency: 10Hz ~ 55Hz ~ 10Hz<br>Amplitude: 0.75mm<br>Cycle once a minute, 30 cycles in total<br>(Packing Condition) |  |
| ESD Test                           | ±4kV Human Body Mode 150pF/330Ω<br>±8kV Air Mode 150pF/330Ω  |  |

**Note:**

- 1) Each module under test can only be used for one of the test items.
- 2) The quantity of samples for each test item is 2.
- 3) **Fault Judgment Criterion: Basic Specifications, Electrical Specifications, Mechanical Specifications, Optical Specifications.**

## 7. Precautions

- 7.1. The display screen consists of glass and polarizer. Since the glass is fragile, the user must pay special attention to the edge area, and protect it from falling, vibration, or mechanical impact.
- 7.2. If the display screen is damaged and the liquid crystal material leaks, be sure not to get any in the mouth. If the liquid crystal material contacts the skin or clothes, flush off with soap and water.
- 7.3. Do not apply excessive force to the display screen or the joint part, or the color will change. Do not touch the display screen with bare hands, which will stain the display area and degraded insulation between terminals (some of the appearance is determined by the polarizer).
- 7.4. The polarizer covering the display panel of the LCD module is soft and easy to be scratched, be sure to handle carefully. Do not touch, impact, press, or rub the exposed polarizers with anything harder than an HB pencil lead (e.g.: glass, tweezers, etc.). Do not place or attach anything onto the display area to avoid leaving marks. The condensed material on the surface or terminals due to cold will damage or stain the polarizer. After the test in low temperature environment, the product must be warmed up in a container before put into the room temperature environment.
- 7.5. If the display panel is stained, blow warm air onto the surface and gently wipe it with a soft and dry cloth. If it is seriously contaminated, wipe it with a wet cloth dipped in one of the following solvents:
  - glycerol
  - ethyl AlcoholDo not scrub, and avoid damaging the display panel.
- 7.6. Solvents other than those mentioned above may damage the polarizer. In particular, never use any of the following solvents:
  - water
  - ketone
  - areneWipe off saliva or water drop immediately, the contact with water over a long period of time may cause deformation or color fading. Avoid contact with oil or grease.
- 7.7. Special note: minimize electrode corrosion. Because electrode corrosion can be accelerated by water droplets, condensation of humidity, or electrification in a high humidity environment.
- 7.8. Assemble the LCD Module by the mounting holes. Make sure the LCD module make sure there is no bending, distortion, or deformation. Do not forcibly pull or bend the transmission wire or the backlight wire.

- 7.9. Do not disassemble the LCD module.
- 7.10. NC terminal should be disconnected. Do not connect any device.
- 7.11. If the logic circuit power supply is off, do not send the input signal.
- 7.12. Since the LCD module is integrated with CMOS, pay special attention to the modules. To prevent electrostatic damage, be careful to maintain a suitable work environment.
- Make sure the module has the same potential as the human body before take the LCD module out of the packing box for assembly. The reliable grounding is necessary during module processing.
  - The required tool, such as the electric soldering iron, must be reliably grounded. Make sure the it is connected to AC power supply, and no electric leakage. When fixing the module with electric screwdriver, it must be grounded, to reduce the electromagnetic wave generated by the electric commutator spark as much as possible.
  - Do not assemble or operate under dry condition to reduce the static electricity. To reduce static electricity, the workplace must not be too dry. The recommended relative humidity is 50 - 60%.  
Keep your work clothes and work table grounded as much as possible
  - The LCD module is coated with a film to protect the display surface. Be careful when peeling off the film to reduce the generated static electricity.
- 7.13. Since the LCD module has high precision assembly and regulation, try to avoid excessive impact on the module or making any changes:
- Do not change the shape of the tab on the metal frame.
  - Do not drill any extra hole, modify the shape, or change the position of component on the printed circuit board.
  - Do not change or damage the pattern on the printed circuit board.
  - Never modify the zebra strip (conductive rubber) or heat seal connector.
  - Do not make any change with the electric soldering iron except for the joint.
  - Do not throw, bend or twist.

## 8. Packing and Storage

### 8.1. Packing Method

Step 1

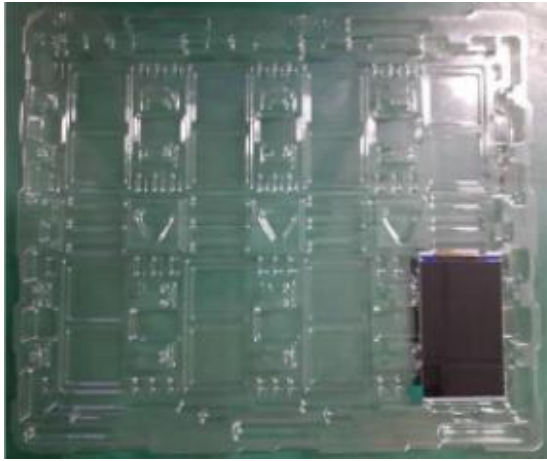

Take 1pcs of the product, put it into a anti-static bag.

Step 2

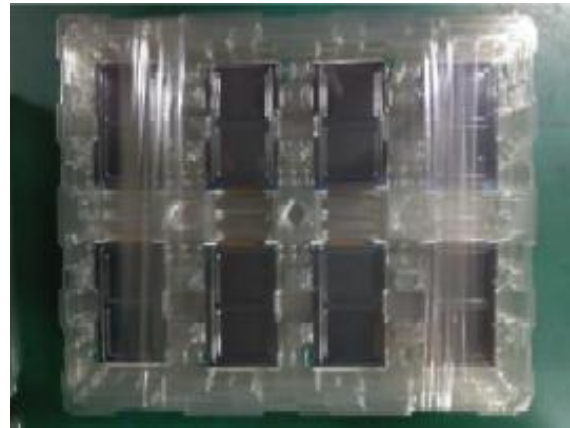

Take 2 bags of product to place into the carton, make sure they are surface to surface. Put a piece of EPE pad between the carton and the separator to protect the products.

Step 3



Put the products into cartons one by one, each carton contains 60 pieces of products.

Step 4



The cartons should be taped and shipped with labels.

### 8.2. Storage Method

Store in an ambient temperature of  $23\pm 5^{\circ}\text{C}$ , and in a relative humidity of  $60\pm 15\%$ . The storage period should not exceed 12 months. Do not expose to the sun for a long period of time.

8.2.1. Store in clean environment, free from dust, active gas, or solvent.

8.2.2. Store in anti-static environment.

### 8.3. Nomenclature

PART NO: Z 4 3 0 2 6 - P 4 0 - XXXX - 总成 1

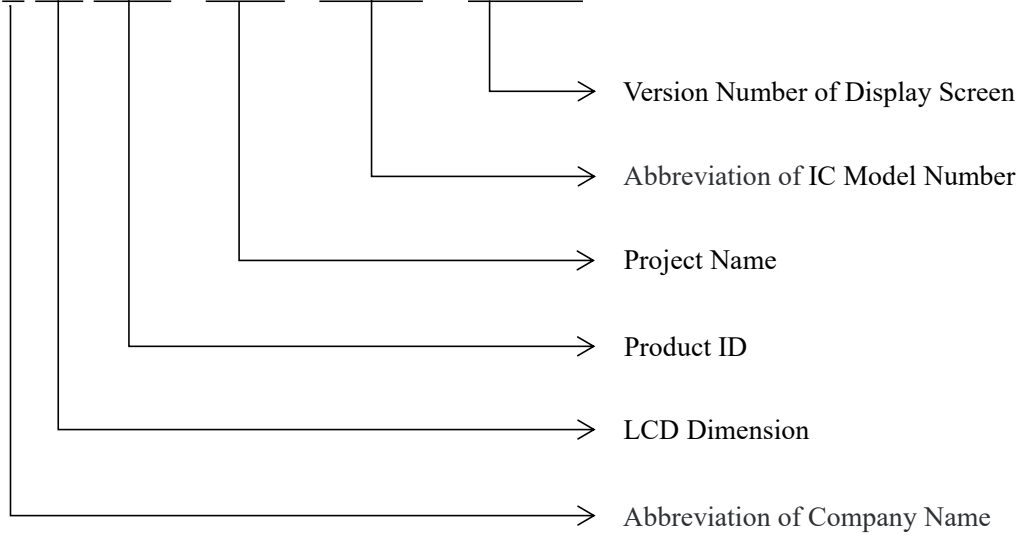

### 8.4. Label

| <b>Shenzhen Zhunyi Technology Co., Ltd.</b> |  |         |
|---|--|---------|
| Product:                                    | Display Screen                               | LEVEL:3 |
| Spec.:                                      |  |         |
| P/N:  |  |         |
| Lot:  |  |         |
| D/C   |  |         |
| Qty.:                                       |  |         |
| Supplier Code:                              |  |         |
| PO  |  |         |
| R/K   |  |         |
| Version: A                                  | XXXXXXXX, YYYY-0000000000000000, KKKK, WWWW, | AAAAA.  |

